

NEW



VORTICENT C E RANGE

Centrifugal fans



Suitable for residential, commercial and industrial applications as kitchens, bathrooms, offices, laboratories, factories, shops, laundromats, models, restaurants, bars, theatres, ballrooms, etc.

- **21 models: 9 single-phase and 12 three-phase.**
- Steel double-coated protected by polyester paint, resistant to atmospheric agents.
- AC motors with ball bearings.
- Motor supports and air vents designed to minimise turbulences and noise levels.
- Galvanised steel mounting brackets supplied.
- Electric supply 230 V / 50 Hz for single-phase models and 400 V / 50 Hz for three-phase models.
- Protection rating: IP55.
- Insulation class: I.
- **Complying with the requirements of Regulation N° 327/2011/UE (Lot 11, 1st Tier) set out by the EUP/ErP Directive, effective starting from 01.01.2013.**

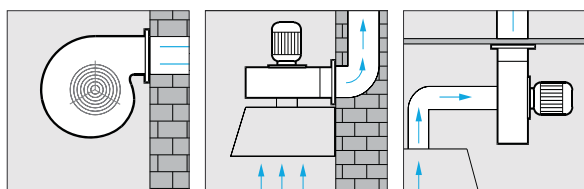

Wiring diagrams shown from page 458

TECHNICAL DATA

	Models	Code	W	A	POLES	RPM	Max Airflow		Max Pressure		Lp dB(A) a 3 m*	Max °C
							m³/h	l/s	mmH ₂ O	Pa		
Single-phase	C 10/2 M	30302	100	0.45	2	2800	300	83.3	25	245	55.5	50
	C 15/2 M	30902	160	0.70	2	2800	450	125	45	441	59	
	C 20/2 M E	30321	400	1.76	2	2800	890	247	52.6	516	66	
	C 25/2 M E	30323	430	1.90	2	2800	1000	277	63	618	66.5	
	C 30/2 M E	30325	740	3.20	2	2800	1420	394.4	84	824	71	
	C 30/4 M E	30327	132	0.582	4	1400	700	194	19.8	194	55	
	C 35/4 M E	30330	370	1.60	4	1400	1520	422.2	34	334	61	
	C 37/4 M E	30332	675	2.95	4	1400	2150	597.2	45.1	442	70	
	C 40/4 M E	30334	790	3.47	4	1400	2650	736	49.3	483.1	73	
Three-phase	C 10/2 T	30351	130	0.30	2	2800	270	75	25	245	55.5	
	C 15/2 T	30951	160	0.35	2	2800	430	119.4	43	422	59	
	C 20/2 T E	30322	390	0.785	2	2800	244	880	52.9	519	66	
	C 25/2 T E	30324	470	1.25	2	2800	1060	294.4	59	579	66.5	
	C 30/2 T E	30326	720	1.50	2	2800	1350	375	85	834	71	
	C 30/4 T E	30328	110	0.19	4	1400	655	182	13.2	176	55	
	C 31/4 T E	30329	280	0.60	4	1400	1100	305.6	31	304	61	
	C 35/4 T E	30331	350	0.70	4	1400	1550	430.6	34	334	61	
	C 37/4 T E	30333	700	2.10	4	1400	2300	638.9	47	461	70	
	C 40/4 T E	30335	800	2.15	4	1400	2900	805.6	49	481	73	
	C 45/4 T E	30336	1900	4.35	4	1400	4500	1250	74	726	70.5	
	C 46/4 T E	30337	3900	7.00	4	1400	6800	1888.9	98	961	76.5	

* Sound pressure level measured at 3 m in free field conditions with long-cased appliance in delivery mode, in accordance with standard EN ISO 3741:2009.



ErP data

Directive 2009/125/EC ErP (Energy related Products)

	Models	Code	Measurement cat.	Efficiency cat.	Year of construction	Variable drive	η	N.	(kW) Pe	BEP*			Spec. ratio <1.04
										m³/h q	Pa p	RPM	
Single-phase	C 20/2 M E	30321	B	TOTAL	01-01-13	NO	31.9	42.1	0.245	533	527.6	2939	YES
	C 25/2 M E	30323					32.8	42.5	0.298	697	505	2866	
	C 30/2 M E	30325					41.6	50.0	0.465	876	584	2892	
	C 35/4 M E	30330					32.4	42.2	0.278	1009	321.5	1433	
	C 37/4 M E	30332					35.4	43.5	0.476	1463	415.1	1454	
	C 40/4 M E	30334					36.8	44.8	0.537	1812	392.28	1444	
Three-phase	C 20/2 T E	30322					34.3	44.6	0.231	535	533	2931	
	C 25/2 T E	30324					33.3	42.8	0.309	706	524.5	2949	
	C 30/2 T E	30326					43.2	51.8	0.434	866	779.5	2914	
	C 31/4 T E	30329					31.1	42.1	0.180	680.6	295.2	1460	
	C 35/4 T E	30331					41.1	51.5	0.230	1021	222	1443	
	C 37/4 T E	30333					38.1	46.6	0.464	1490	427.6	1475	
	C 40/4 T E	30335					39.0	47.5	0.451	1503	421.7	1478	
	C 45/4 T E	30336					49.7	56.3	0.913	2399	681.5	1472	
C 46/4 T E	30337	41.6	45.7	2.250	4075	827	1470						

* Best efficiency point.

Orientation

The position of a radial fan delivery outlet is represented by a direction of rotation symbol (LG - that is, towards the left or anti-clockwise, looking from the side opposite the air intake inlet) and the angle (in degrees) of the delivery outlet to the reference axis (a straight line perpendicular to the base plane, passing through the axis of rotation), measured in the direction of rotation.

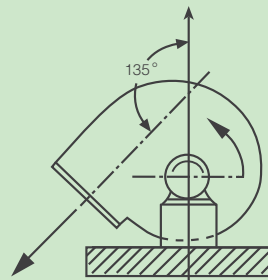

Designation of delivery outlet position for radial fans.

Adjacent example: LG 135

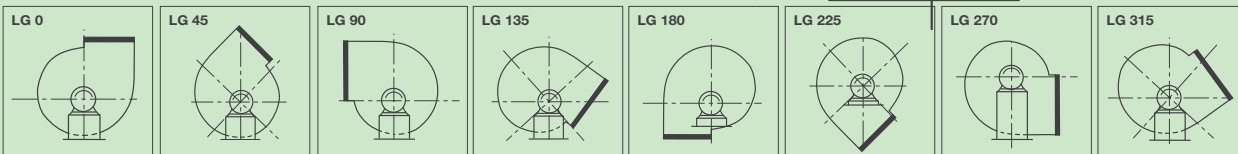

DIMENSIONS

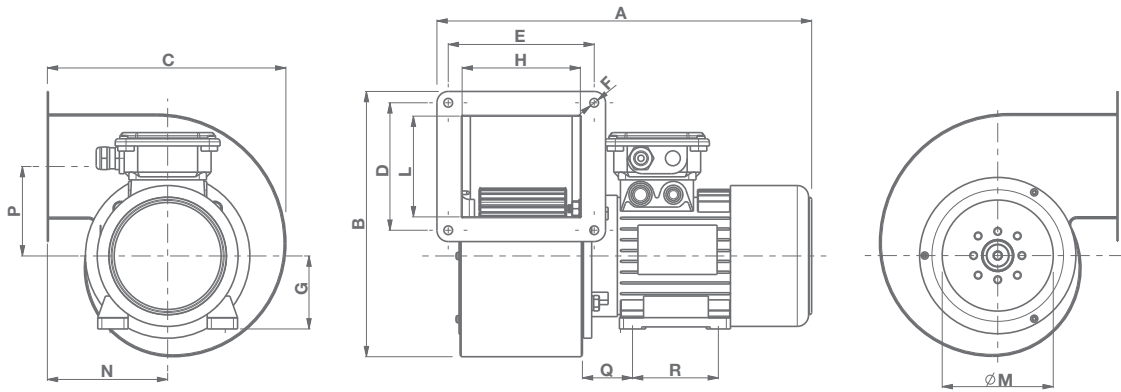

Models	A	B	C	D	E	F	G	H	L	ØM	N	P	Q	R	Kg
C 10/2 M	260	186	171	72	82	6.5	56	68	63	80	81	66.5	36	71	2.7
C 10/2 T															4.6
C 15/2 M	281	234	206	108	100	7	56	83	88	108	99	79	36	71	5
C 15/2 T															3.3
C 20/2 M E	350	258	232	123	123	8.5	71	102	98	108	117	87	45	90	6
C 20/2 T E															6.3
C 25/2 M E	366	258	232	124	142	8.5	71	115	98	108	117	87	45	90	6.8
C 25/2 T E															6.3
C 30/2 M E	352	308	272	126	137	8.5	71	117	108	132	131	111	45	90	8.4
C 30/2 T E															8.1
C 30/4 M E	351	400	340	164	139	8.5	71	112	137	170	152	144	45	90	9
C 30/4 T E															8.1
C 31/4 T E	387	400	340	164	174	8.5	71	149	137	170	152	144	45	90	9.5
C 35/4 M E	435	471	416.5	220	182	8.5	71	149	187	199	181.5	146	50	100	11
C 35/4 T E															9.3
C 37/4 M E	466	472	418	214	208	8.5	80	185	187	199	181.5	147	50	100	20.5
C 37/4 T E															14.6
C 40/4 T E	549	557.2	484.5	228	228	9	90	200	200	240	222	217	56	125	21
C 40/4 M E															21
C 45/4 T E	549	557.2	484.5	228	228	9	90	200	200	240	222	217	56	125	61

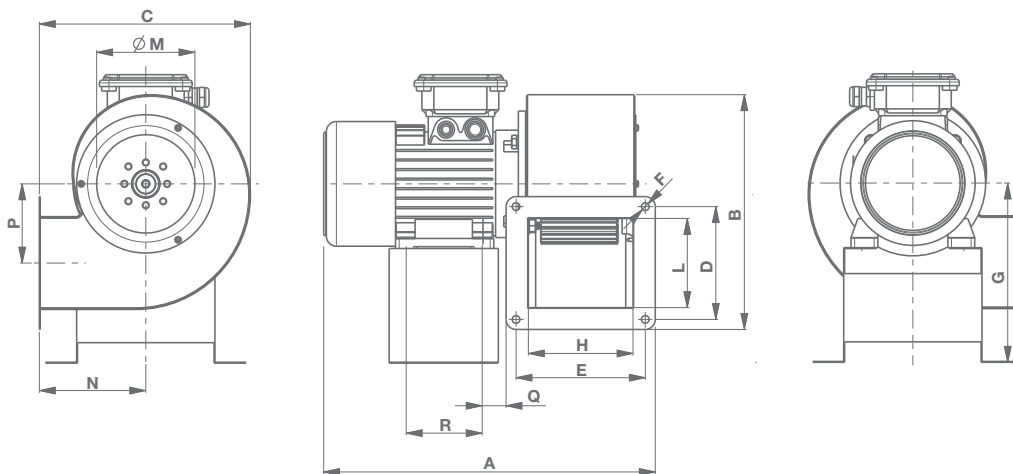

Models	A	B	C	D	E	F	G	H	L	ØM	N	P	Q	R	Kg
C 46/4 T E	593	675	566	306	265	11.5	442	236	277	288	250	244.5	27	270	61

Dimensions (mm)



Air intake

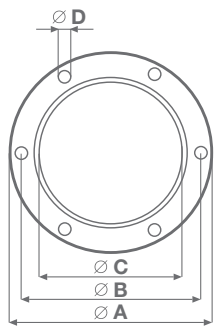

Models	Ø A	Ø B	Ø C	Ø D	n° holes
C 10	111.5	100	80	7	6
C 15	141	128			
C 20	152	132	108		
C 25			132		
C 30	190	170	132	8.5	8
C 31	240	220	170		
C 35					
C 37	282	262	199		
C 40					
C 45					
C 46	420	395	288		

Delivery outlet

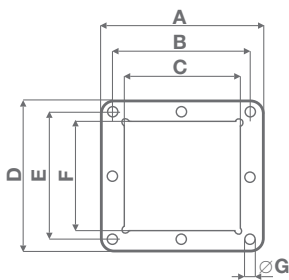



Models	A	B	C	D	E	F	Ø G	n° holes
C 10	98	82	68	88	72	63	6.5	4
C 15	125	100	83	132	108	88	7	
C 20	145	123	102	145	123	98	8.5	
C 25	164	142	115	146	124			
C 30	162	137	117	150	126	108		8
C 31	165	139	112	190	164	137		
C 35	200	174	149		250	220	187	
C 37	218	182		214				
C 40	244	208	185	260		228	200	9
C 45	260	228	200	260	228	200	9	8
C 46	295	264	236	336	306	277	11.5	

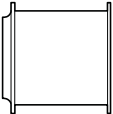
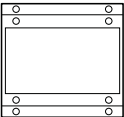

PRODUCT ACCESSORIES

Models	Code	Product																					
		C-10/2 M code 30302	C-15/2 M code 30902	C-20/2 ME code 30321	C-25/2 ME code 30323	C-30/2 ME code 30325	C-30/4 ME code 30327	C-35/4 ME code 30330	C-37/4 ME code 30332	C-40/4 ME code 30334	C-10/2 T code 30351	C-15/2 T code 30951	C-20/2 T code 30322	C-25/2 TE code 30324	C-30/2 TE code 30326	C-30/4 TE code 30328	C-31/2 TE code 30329	C-35/2 TE code 30331	C-37/2 TE code 30333	C-40/4 TE code 30335	C-45/4 TE code 30336	C-46/4 TE code 30337	
	C-RA 10 Flanged inlet adapter	22825	●								●												
	C-RA 15 Flanged inlet adapter	22826		●								●											
	C-RA 20/25 Flanged inlet adapter	22828			●	●							●	●									
	C-RA 30 Flanged inlet adapter	22829					●	●							●	●							
	C-RA 31/35 Flanged inlet adapter	22830							●								●	●					
	C-RA 37 Flanged inlet adapter	22832								●									●				
	C-RA 40 Flanged inlet adapter	22833									●										●		
	C-RA 45 Flanged inlet adapter	22834																				●	
	C-RA 46 Flanged inlet adapter	22835																					●
	C-MS 20/25 Wall-mounted support	22836			●	●							●	●									
	C-MS 30 Wall-mounted support	22837					●	●							●	●							
	C-MS 31/35 Wall-mounted support	22838							●								●	●					
	C-MS 37/40 Wall-mounted support	22839								●	●								●	●			
	C-MS 45 Wall-mounted support	22840																				●	

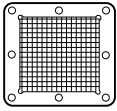

Models	Code	Product																					
		C 10/2 M code 30302	C 15/2 M code 30902	C 20/2 M E code 30321	C 25/2 M E code 30323	C 30/2 M E code 30325	C 30/4 M E code 30327	C 35/4 M E code 30330	C 37/4 M E code 30332	C 40/4 M E code 30334	C 10/2 T code 30351	C 15/2 T code 30951	C 20/2 T code 30322	C 25/2 T E code 30324	C 30/2 T E code 30326	C 30/4 T E code 30328	C 31/2 T E code 30329	C 35/2 T E code 30331	C 37/2 T E code 30333	C 40/4 T E code 30335	C 45/4 T E code 30336	C 46/4 T E code 30337	
	C-GM 10 Protection grille for outlet port	22811	●								●												
	C-GM 15 Protection grille for outlet port	22812		●								●											
	C-GM 20 Protection grille for outlet port	22813			●								●										
	C-GM 25 Protection grille for outlet port	22814				●								●									
	C-GM 30 Protection grille for outlet port	22816					●	●							●	●							
	C-GM 31 Protection grille for outlet port	22817															●						
	C-GM 35 Protection grille for outlet port	22818							●									●					
	C-GM 37 Protection grille for outlet port	22819								●									●				
	C-GM 40 Protection grille for outlet port	22820									●										●		
	C-GM 45 Protection grille for outlet port	22821																				●	
	C-GM 46 Protection grille for outlet port	22822																					●
	C-GA 10 Protection grille for intake port	22801	●								●												
	C-GA 15 Protection grille for intake port	22802		●								●											
	C-GA 20/25 Protection grille for intake port	22803			●	●							●	●									
	C-GA 30 Protection grille for intake port	22804					●	●							●	●							
	C-GA 31/35 Protection grille for intake port	22805							●								●	●					
	C-GA 37/40 Protection grille for intake port	22806								●	●								●	●			
	C-GA 45 Protection grille for intake port	22807																				●	
	C-GA 46 Protection grille for intake port	22808																					●

Description and sizes on page 325; System components on page 300.



PERFORMANCE CURVES

C 10/2 M code 30302

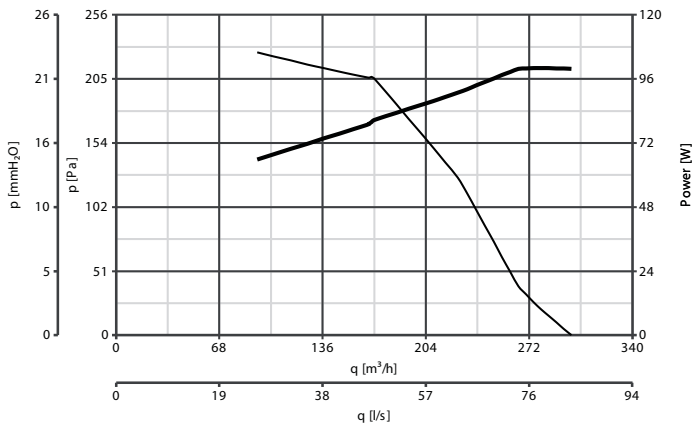

C 10/2 T code 30351

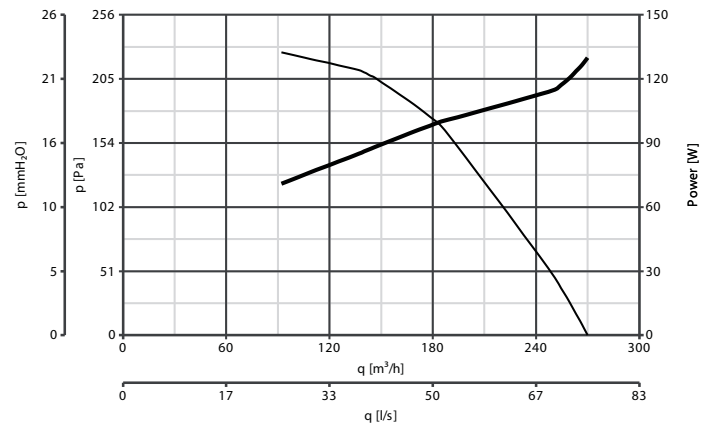

C 15/2 M code 30902

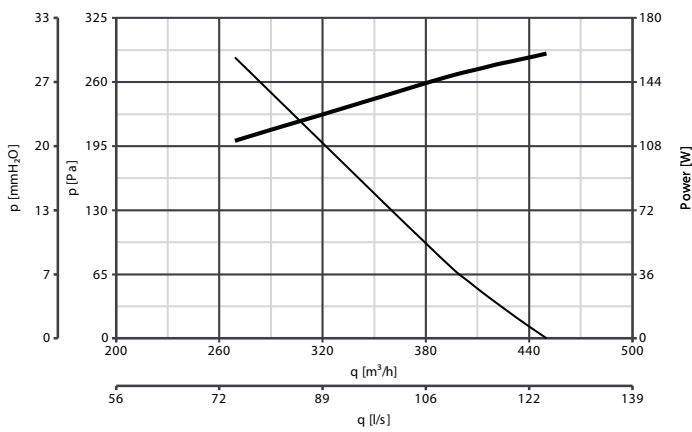

C 15/2 T code 30951

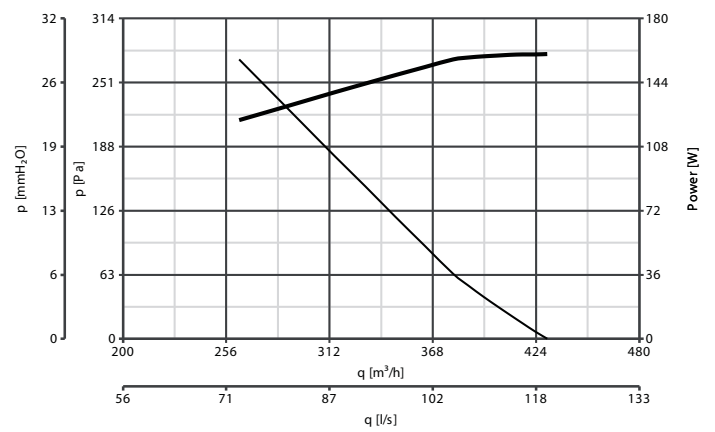

C 20/2 M E code 30321

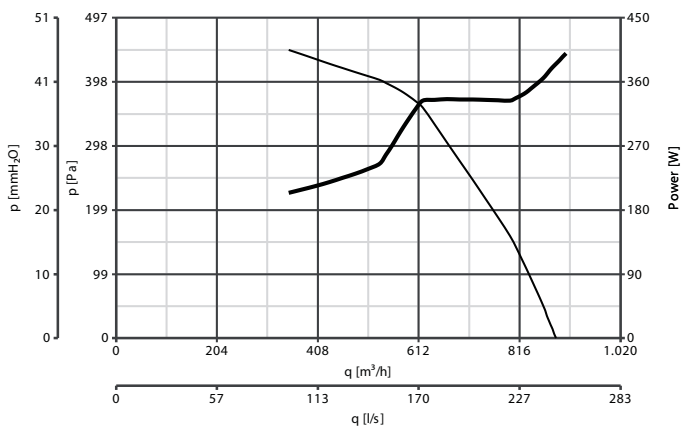

C 20/2 T E code 30322

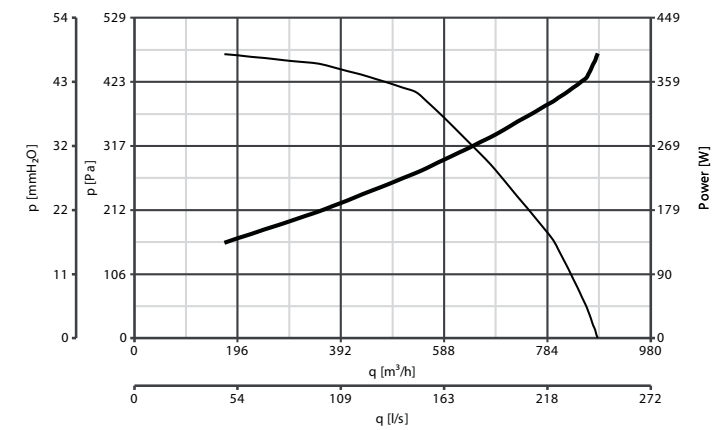

C 25/2 M E code 30323

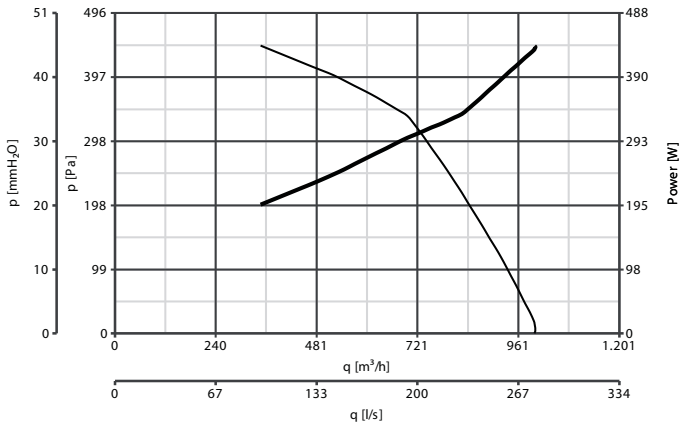

C 25/2 T E code 30324

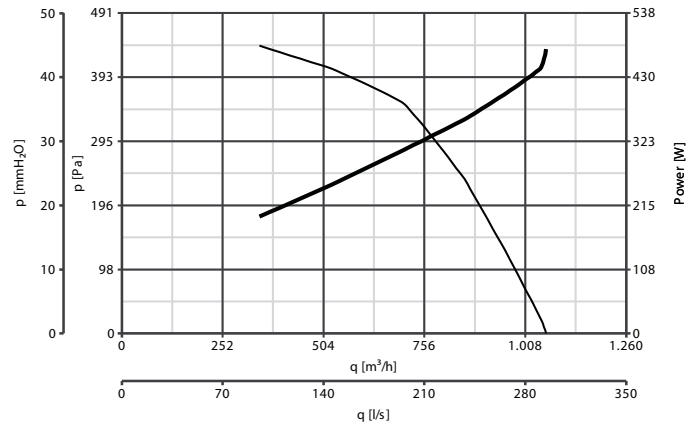

C 30/2 M E code 30325

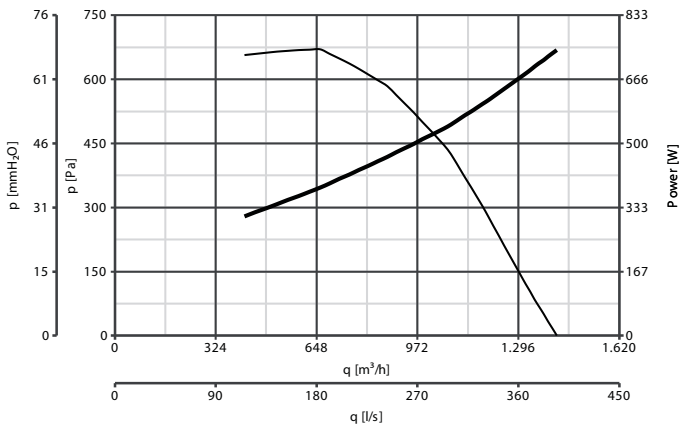

C 30/2 T E code 30326

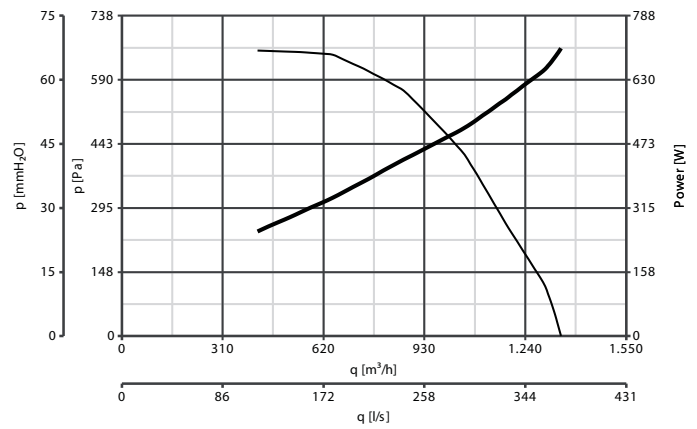

C 30/4 M E code 30327

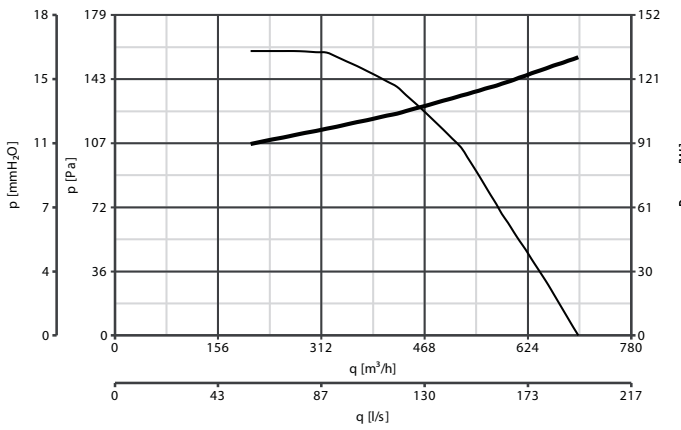

C 30/4 T E code 30328

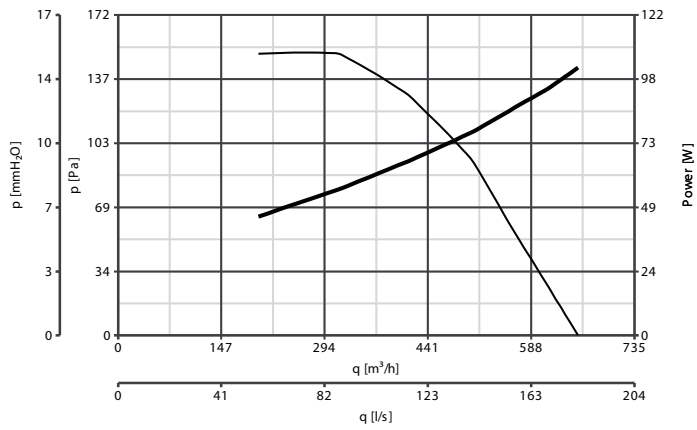

C 31/4 T E code 30329

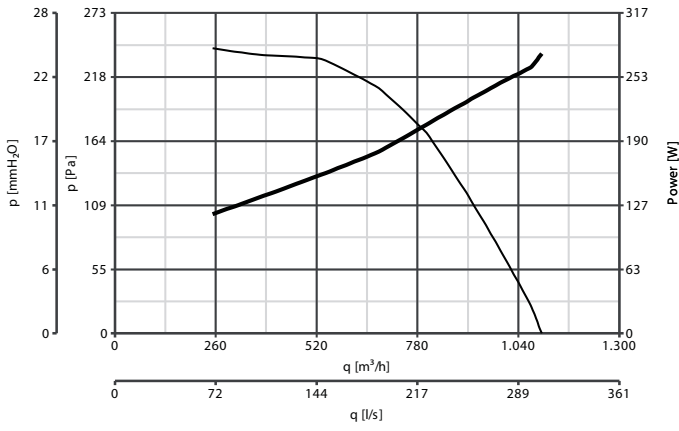

C 35/4 M E code 30330

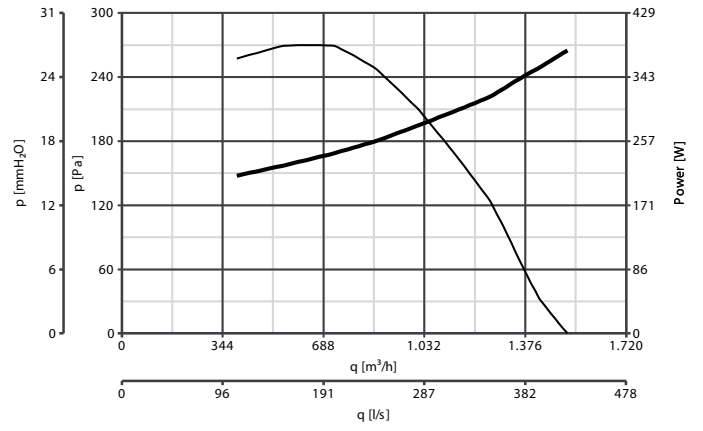

C 35/4 T E code 30331

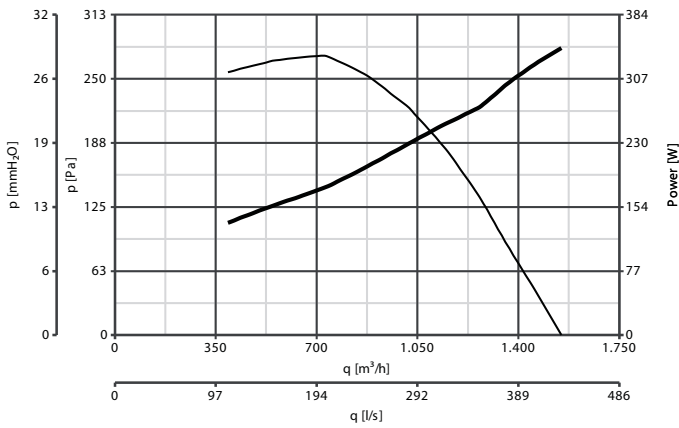

C 37/4 M E code 30332

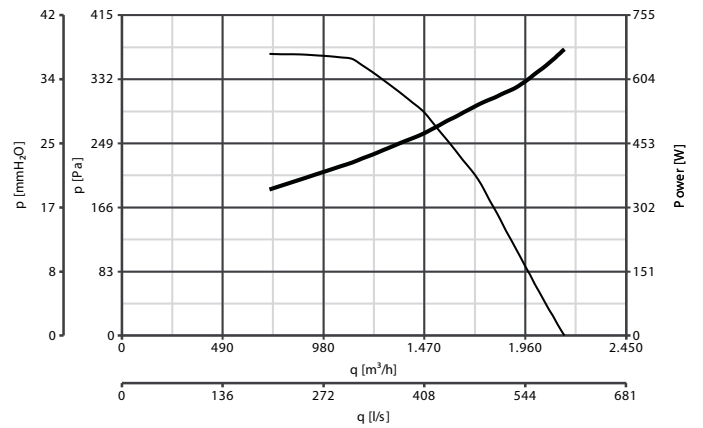

C 37/4 T E code 30333

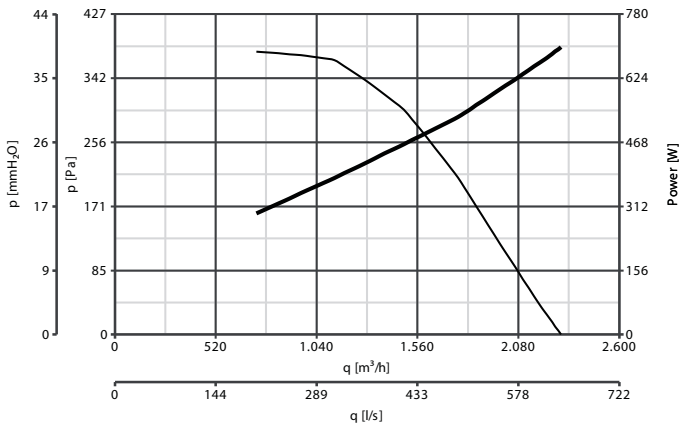

C 40/4 M E code 30334

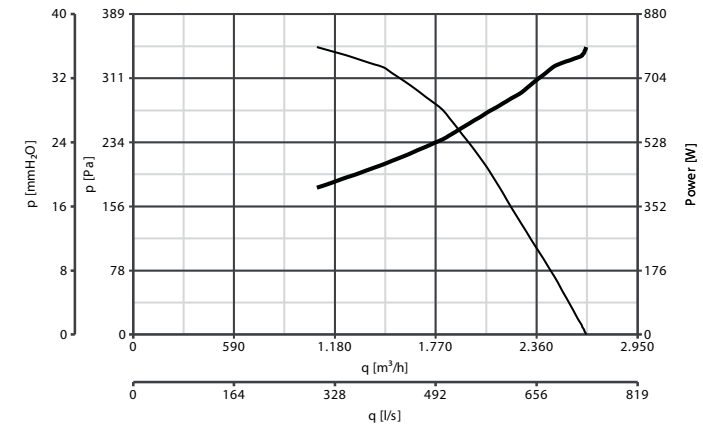

C 40/4 T E code 30335

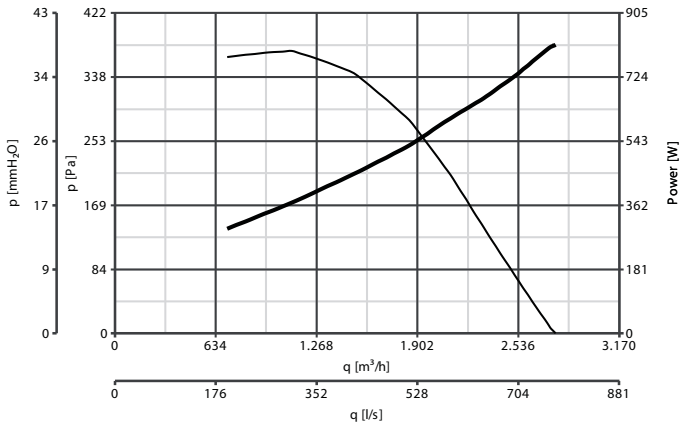

C 45/4 T E code 30336

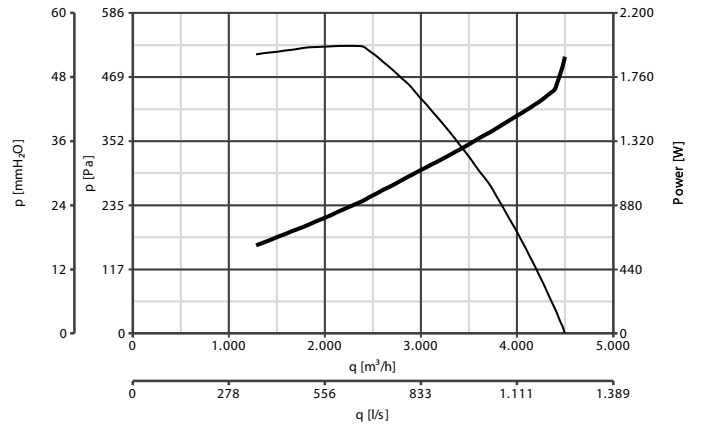

C 46/4 T E code 30337

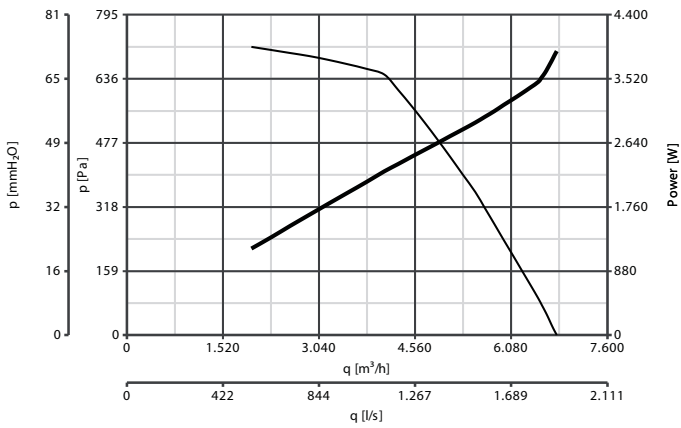

— Delivery — Consumption

